

CATALOGUE
CONTENTS
21.04.2009

	page
NIOS 1 : oriëntation-, ambient-lighting, profiles, adaptors led's	01 - 10
NIOS 2 : flexibles led's	11 - 20
NIOS 3 : ceiling- wall- & suspensions lamps led's or bulbs	21 - 30
NIOS 4 : interior lighting - 12 volt	31 - 40
NIOS 8 : outdoor lighting westhinder led's or bulbs	71 - 80

All models are registered
 and protected by prevailing laws



1 ORIENTATION, PROFILES ADAPTORS 1



21.04.2009
 Design: Luc Lemahieu

PAGE 01-10

CONTENTS

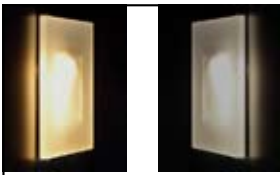

INZO SMALL p.2
 Oriëntation lighting
 for wall mounting
 1 watt led, x1



INZO MEDIUM p.3
 Oriëntation or general lighting
 for mounting IN wall or shelf
 1 watt led, 1, 2 of 4x



ONZO p.4
 Oriëntation or general lighting 110°
 for mounting ON wall or shelf
 1 watt led, 1, 2 of 4x

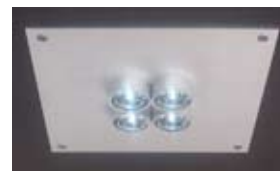

ONZO SPOT p.5
 Oriëntation or general lighting 13°, 25° or
 50°. For mounting ON wall or shelf
 1 watt led, 1, 2 of 4x



ZORRO EST ARRIVE p.6
 Led reading light
 Light emission 110°
 1 watt led, x4



PONZO PROFIELEN p.7 & 8
 General or accent lighting
 13°, 25° or 50°.
 For mounting in or on wall or shelf



ADAPTORS -VOEDINGEN
 current controlled AC/DC adaptors
 350mA for 1W LEDs p. 9
 700mA for 3W LEDs p. 10

NIOS is door LUXEON™ geselecteerd als
 CERTIFIED LUXEON LUMINAIRE MANUFACTURER

RECUPEL Recycling charge in Belgium
 each model for standard-, halogen-
 or energy saving bulb 230V,
 low voltage bulb or LEDS
 05.09.02 : euro 0,05 incl. VAT



▲ profile B - pag.7, 8 dancer in the dark 16 - pag. 24 ▼



▲ ufo8a 50 - pag.26



▼ lio table - pag. 20 pag. 74 - westhinder 360° medium ▲



Models, prices and dimensions (in mm)
can be altered without previous notice.
Inclusive LEDs
Prices in EURO



INZO - SMALL led orientation lighting - 1W



All models are registered
and protected by prevailing laws.
Scale 1/1 21.04.2009
Design: Luc Lemahieu

MODEL ACCESSORIES

For mounting in wall (with wall-box Helia nr. 113) or directly in a cupboard, wardrobe, book-case or staircase. Housing is anodised aluminium. The cover is sanded transparent PMMA. With one power-led, 1 watt.

Colour filters,
see at the bottom.

ADVANTAGES ADAPTOR

If there is little space to build on, fits in 16 mm thickness shelf.
Advantags led's see page 1

To be connected in series (sequence circuit) on AC/DC adaptor 350mA max.
To order see page 9



INZO SMALL white warm

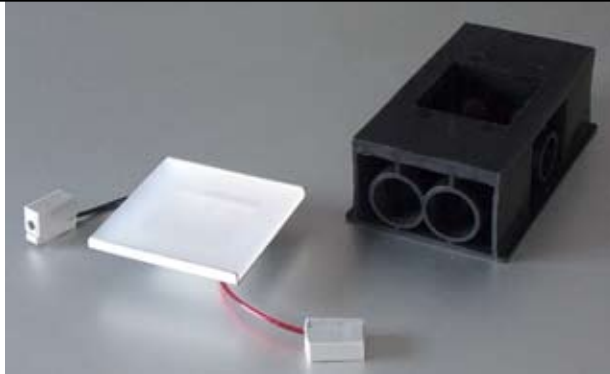

INZO SMALL & wallbox helia nr.113 - dim.110 x 68 x 38 mm hgt
hole 39 x 39 x 35 mm



with grey filter INZO SMALL

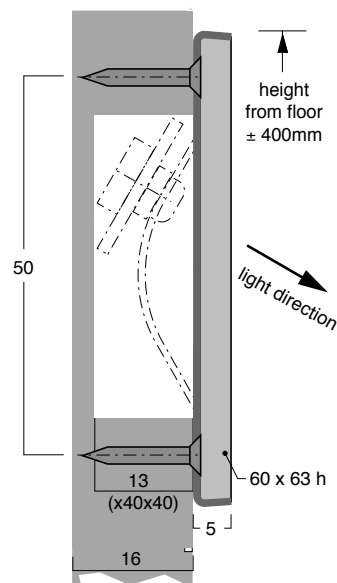

INZO SMALL

scale 1/1

INZO SMALL - 1 led

APPLICATION

orientation wall light
for night hall & corridors.

INZO SMALL - 1W	light colour	art. code	€ in.
WITH SCREWS	white cold	ISS1 WC	76,0
1 led	white warm	ISS1 WW	79,0
TO GLUE	white cold	ISK1 WC	76,0
1 led	white warm	ISK1 WW	79,0
wall box helia nr 113		ZHELIA113	2,5

COLOUR FILTERS - INZO SMALL

fits between housing and transparent cover

model	colour	art.code	€ in.
COLOUR FILTER	white (warm)	IS WW	3,0
inzo small	grey (for dimming-warm)	IS GY	3,0
	jade (soft green/blue)	IS GN	3,0
	lavender (soft)	IS LV	3,0
	red	IS RD	3,0
	blue	IS BL	3,0

Models, prices and dimensions (in mm) can be altered without previous notice.
Inclusive LEDs
Prices in EURO



INZO - MEDIUM led orientation lighting - 1,2,4W



All models are registered and protected by prevailing laws.
Scale 1/2 21.04.2009
Design : Luc Lemahieu

<p>MODEL</p> <p>For mounting in the wall, ceiling or shelf (furniture), with 1, 2 or 4 LEDs of 1 watt. Fits in standard wall-boxes or directly in a horizontal placed bticino box 503E. Housing in anodised aluminium. Cover in sandblasted transparent PMMA. With 1, 2 or 4 power-led's (1 watt)</p> <p>ADVANTAGES</p> <p>If there is little space to build in, fits in 16 mm thickness shelf. Advantags led's see page 1</p>	<p>ACCESSORIES</p> <p>Colour filters, see at the bottom.</p>
	<p>ADAPTOR</p> <p>To be connected in series (sequence circuit) on AC/DC adaptor 350mA max. To order see page 9</p>

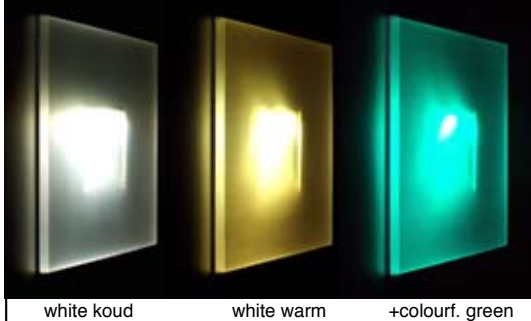

white koud white warm +colourf. green

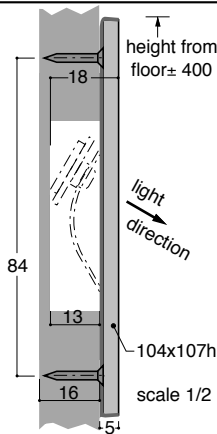

INZO MEDIUM
1 or 2

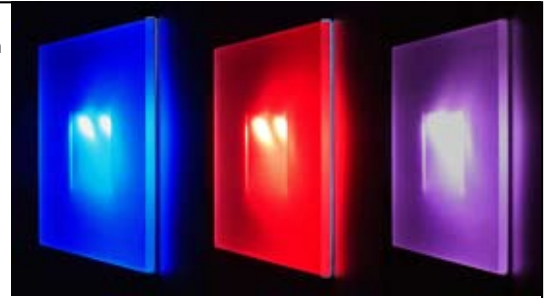

+colourf. blue +colourf. red +colourf. +lavendel

INZO MEDIUM - 1 led
APPLICATIONS

Build in orientation wall light,
 for night-time use (hall & corridors)

INZO MEDIUM - 1W	light colour	art. code	€ in.
WITH SCREWS	white cold	IMS1 WC	96
1 led	white warm	IMS1 WW	99
TO GLUE	white cold	IMK1 WC	96
1 led	white warm	IMK1 WW	99
adaptor 350mA 1x1w - afm. 51x32x18mm		ZMPL1	25

INZO MEDIUM - 2 led's
APPLICATIONS

Build in orientation wall light,
 for day- and night-time use, dark corridors (in apartments)

INZO MEDIUM - 2W	light colour	art. code	€ in.
WITH SCREWS	white cold	IMS2 WC	123
2 led's	white warm	IMS2 WW	128
TO GLUE	white cold	IMK2 WC	123
2 led's	white warm	IMK2 WW	128
adaptor 350mA 2x1w - afm. 51x32x18mm		ZMPL3	25



INZO MEDIUM - 4 led's
APPLICATIONS

Build in for general light. Light intensity comparable
 incandescence bulb or 20w halogen low energy saving bulb.

INZO MEDIUM - 4W	light colour	art. code	€ in.
WITH SCREWS	white cold	IMS4 WC	178
4 led's	white warm	IMS4 WW	188
TO GLUE	white cold	IMK4 WC	178
4 led's	white warm	IMK4 WW	188
adaptor 350mA 4x1w - afm. 51x32x18mm		ZPLR110	35

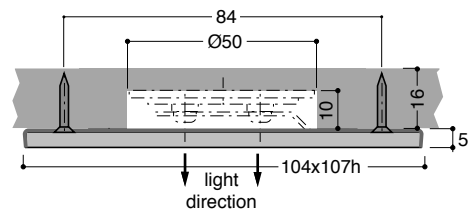

INZO MEDIUM 4

scale 1/2



COLOUR FILTERS - INZO MEDIUM

fits between housing and transparent cover.

model	colour	art.code	€ in.
COLOUR FILTER	white (warm)	IM WW	5
inzo medium	grey (for dimming-warm)	IM GY	5
	jade (soft green/blue)	IM GN	5
	lavender (soft)	IM LV	5
	red	IM RD	5
	blue	IM BL	5

Models, prices and dimensions (in mm)
can be altered without previous notice.

Inclusive LEDs
Prices in EURO



ONZO led lighting - 1, 2, 4W



All models are registered
and protected by prevailing laws.
Scale 1/2 21.04.2009
Design: Luc Lemahieu

MODEL ACCESSORIES

Build-on, very compact general lighting, 110° angle.
For mounting on the wall, ceiling or shelf (furniture). Housing in anodised
aluminium. Fixed by 2 screws. With 1, 2 or 4 power-led's, 1 watt.

none

ADVANTAGES ADAPTOR

If there is little space to build on. Only 7,5mm thickness.
Advantages led's see page 1

To be connected in series (sequence circuit) on AC/DC adaptor 350mA max.
To order see page 9

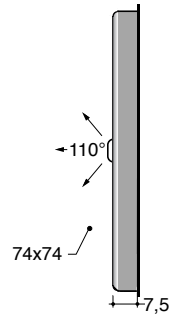
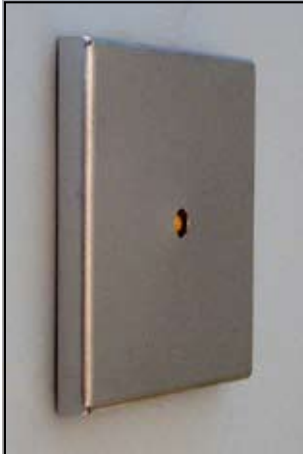

ONZO 1

scale 1/2

ONZO - 1 led

APPLICATIONS

Build-on orientation wall light,
for night-time use (hall & corridors).

ONZO - 1W	light colour	art. code	€ in.
1 led	white cold	ONZ1 WC	89
	white warm	ONZ1 WW	92

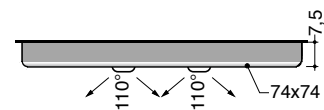

ONZO 2

scale 1/2

ONZO - 2 led's

APPLICATIONS

Build-on orientation wall light, for day- and
night-time use, dark corridors (in apartments).

ONZO - 2W	light colour	art. code	€ in.
2 led's	white cold	ONZ2 WC	113
	white warm	ONZ2 WW	118

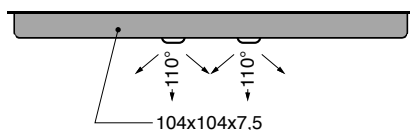

ONZO 4

scale 1/2

ONZO - 4 led's

APPLICATIONS

Build-on general lighting with 110° light emission
(ideal to illuminate a 40x40 cm surface
from a short distance (±30/50 cm), for example in presentation cabinets).

ONZO - 4W	light colour	art. code	€ in.
4 led's	white cold	ONZ4 WC	163
	white warm	ONZ4 WW	173



MODEL ACCESSORIES

Build-on, very compact accent lighting, 13°, 25° or 50°.
For mounting on the wall, ceiling or shelf (furniture).
Housing in anodised aluminium. With 1, 2 or 4 power-led's, 1 watt.

none

ADVANTAGES ADAPTOR

If there is little space to build on. Only 7,5mm thickness.
Advantages led's see page 1

To be connected in series (sequence circuit) on AC/DC adaptor 350mA max.
To order see page 9

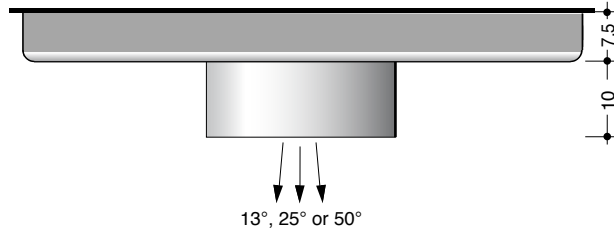

ONZO SPOT 1

scale 1/1

ONZO SPOT - 1 led

APPLICATIONS

Build-on accent light 1 watt, for ceiling or wall, in a corridor or above a door,
comparable with 5 watt microïde spot. Fixed by 2 screws.

ONZO SPOT - 1W	light colour	art. code	€ in.
1 led - 13°	white cold	ONS1-13 WC	124
	white warm	ONS1-13 WW	127
1 led - 25°	white cold	ONS1-25 WC	124
	white warm	ONS1-25 WW	127
1 led - 50°	white cold	ONS1-50 WC	124
	white warm	ONS1-50 WW	127

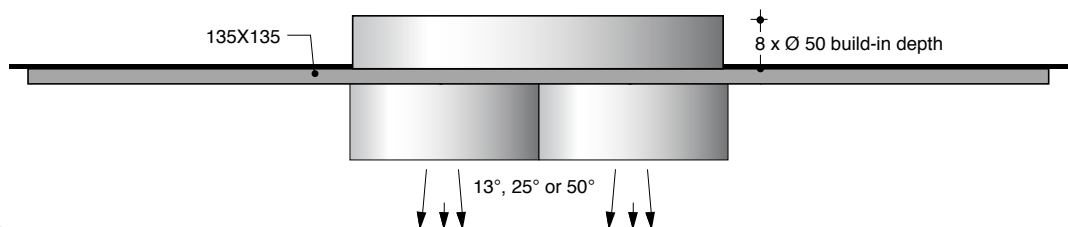

ONZO SPOT 4

scale 1/1

ONZO SPOT - 4 led's

APPLICATIONS

Accent-light, 4x1 watt, can replace a 20 watt microïde spot (can be mounted
on the ceiling or on a shelf). Dimensions 135x135x12mm (big enough to cover
the hole of an old spot). Fixed by 4 screws (visible).

ONZO SPOT - 1W	light colour	art. code	€ in.
4 led's - 13°	white cold	ONS4-13 WC	265
	white warm	ONS4-13 WW	275
4 led's - 25°	white cold	ONS4-25 WC	265
	white warm	ONS4-25 WW	275
4 led's - 50°	white cold	ONS4-50 WC	265
	white warm	ONS4-50 WW	275

Models, prices and dimensions (in mm)
can be altered without previous notice.
Inclusive LEDs and adaptor
Prices in EURO



ZORRO est ARRIVÉ led - desk lamp 4x1W



All models are registered
and protected by prevailing laws.
Scale 1/1 21.04.2009
Design: Luc Lemahieu

SELECTIONS

A new Belgium in ideas and materials

ART ECO, exhibition about design and ecology in cooperation
with Design Flanders and the Flemish info point for Eco-design

Design Awards, Ghent

Henry Van de Velde Awards 2003, Brussels

World best design exchange - Seoul - Korea - 2003

Design from Flanders - Melbourne - Australia - 2004

LABEL-DESIGN.BE

Hornu - Belgium - 2005

BELGIAN DESIGN

Museum Waterland - The Netherlands - 2007

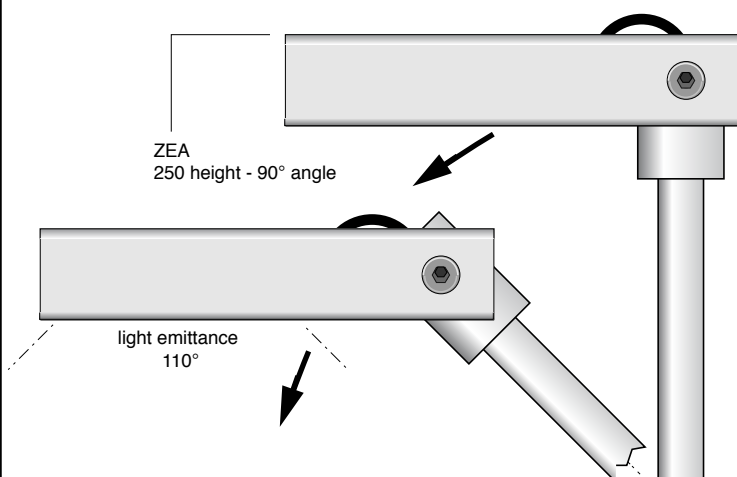

ZORRO est ARRIVÉ

Very compact, light weight, can be folded.

The emitted light is homogeneous and has an ideal light distribution of 110°.

LIGHT EMITTANCE

Lux at a distance of 21 cm, illuminated surface two pages A4.

4x1w with cold LED: ± 580 lux

4x1w with warm LED: ± 440 lux

ADVANTAGES

Very long life time

Very low energy consumption: 4 watt

Low heat emittance

Shock resistant

High light output

ACCESSOIRES

Colour filters for ambient lighting blue, green (warm white), easy to change the filters.

ADAPTOR

With AC euro-plug suitable for 190V tot 265V/AC.

model	light colour	art.code	eu in.
Zorro est arrivé	white cold	ZEA 4C	249,0
4 led's	white warm	ZEA 4W	259,0

dimensions folded:
desk lamp: 294x60x17 mm

turnable

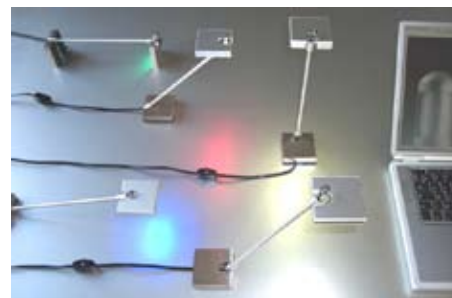

zorro est arrivé ▲

Zorro est arrivé (ZEA)

scale 1/1

GENERAL + ACCENT LIGHT
 aluminium profil 30 x 15 x 2950mm max. lgt

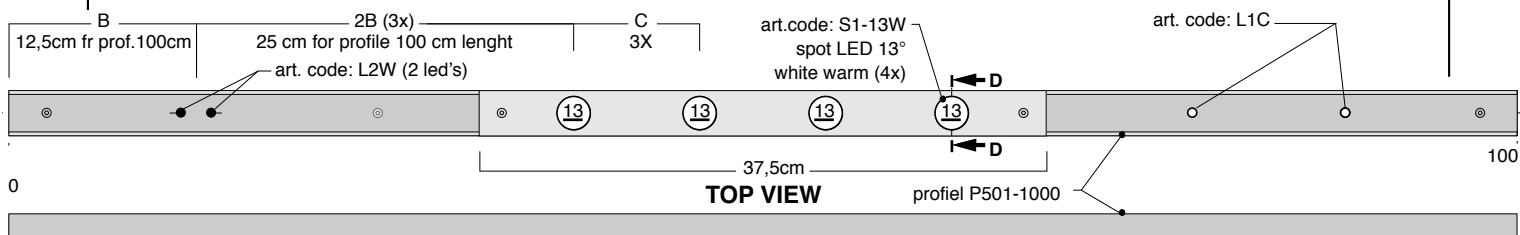

SIDE VIEW
 scale 1/5

EXAMPLE CALCULATION

model	remarks	lenght	art. code	quantity	€ in.	€ in.
profile type A or B	wall or ceiling mounting	1000mm	PA501-1000	1 x	100,0	100,0
LED 100°(2 LEDs)	white cold		L1C	2 x	27,5	55,0
LED 100°(2 LEDs)	white warm		L2W	1 x	60,0	60,0
spot 13° (4x)	white warm		S1-13W	4 x	40,0	160,0
adaptor 1-8 LEDs	190-265v / 350mA for 1watt LEDs		ZPLK110	1 x	35,0	35,0
					total	410,0

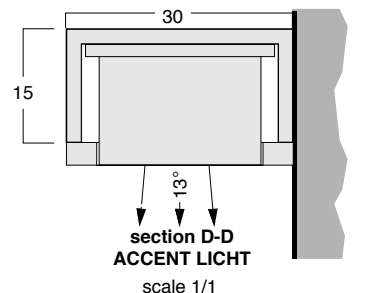

(room for cables at the back) profile type B ▼

APPLICATIONS

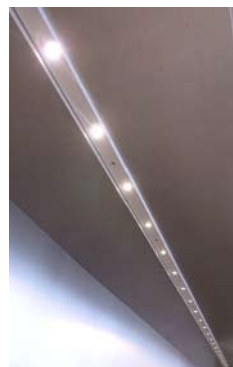

profile type A ▲

▲ directional profile with cable suspension

profile build-in cabinet ▲

with flexible lolo (p.15) ▲

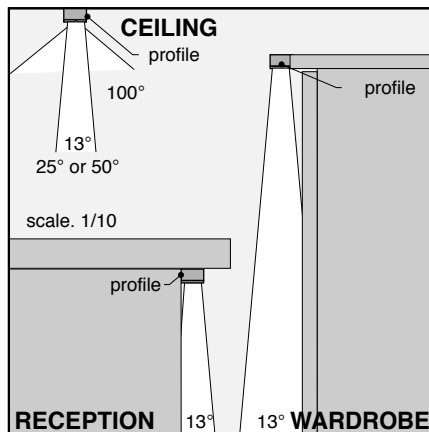
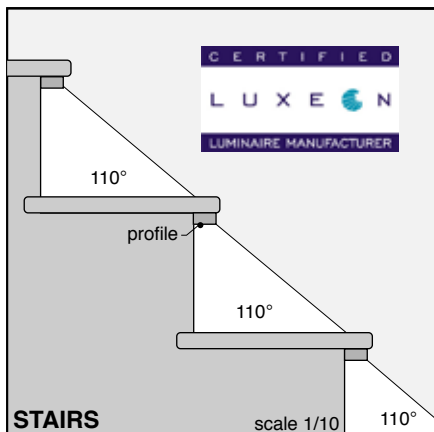
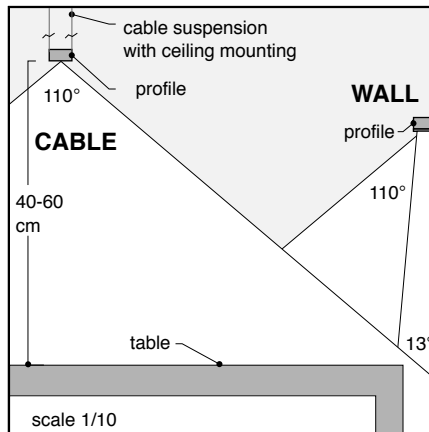
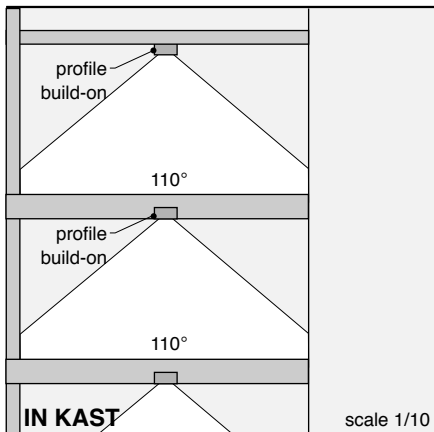

Models, prices and dimensions (in mm) can be altered without previous notice.
Inclusive LEDs and adaptor
Prices in EURO



PONZO - PROFILES
with power-leds 1 or 3 W



All models are registered and protected by prevailing laws.
Scale 1/1 21.04.2009
Design: Luc Lemahieu

OFFER ref.
 ORDERFORM
 DELIVERY NOTE
 nr.
 date.....
 VAT nr.

TO:

 contact
 tel..... fax
 e-mail.....

FROM:

 contact
 tel..... fax
 e-mail.....

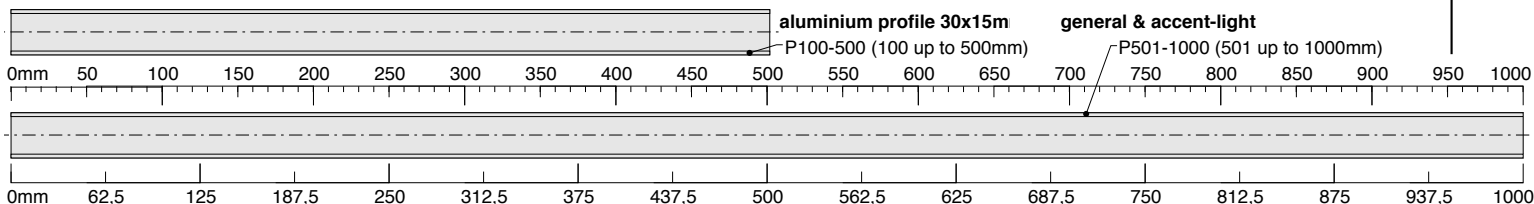

DRAWINGS
 bovenzicht
 dimensions in mm - scale 1/5

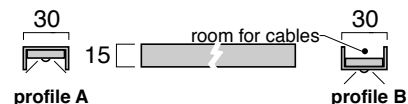

POWER-LEDS
 tech. info pag. 1

PROFILE max. lgt 2950mm (longer by build-on)

model	length	art. code	€ in.	quantity	€ tot.
profile A	100 up to 500mm	PA100-500	65,0		
profile A	501 up to 1000mm	PA501-1000	100,0		
profile B	100 up to 500mm	PB100-500	65,0		
profile B	501 up to 1000mm	PB501-1000	100,0		
profile A of B	extra 1 up to 500mm	P+500	50,0		

LED - 1 watt 350mA

	lichtkleur	art. code	€ in.
○ 110° (standard 125 or 250mm distance)	white cold	L1C	27,5
● 110°	white warm	L1W	30,0
○ ○ 110° x2 (standard 200mm distance)	white cold	L2C	55,0
● ● 110° x2	white warm	L2W	60,0
⊙ 13° (standard 125 or 250mm distance)	white cold	S1-13C	37,5
⊙ 13°	white warm	S1-13W	40,0
⊙ 25°	white cold	S1-25C	37,5
⊙ 25°	white warm	S1-25W	40,0
⊙ 50°	white cold	S1-50C	37,5
⊙ 50°	white warm	S1-50W	40,0

LED - 3 watt 700mA

	lichtkleur	art. code	€ in.
⊙ 110° (standard 125 or 250mm distance)	white cold	L3C	37,5
● 110°	white warm	L3W	40,0
⊙ 3W	3 watt with optic, each LED (13, 25, 50 of 80°)	+OPL3	20,0
	of met flexibels LOLO M10 zie pag.15 & 16
	EXTRA each LED if not standard distance	+PLGTX	5,0

ACCESSORIES

length / remarks	art. code	€ in.
cover (pmma) under 100 up to 500mm/opal	PU 100-500	30,0
cover (pmma) under extra 1 up to 500mm	PUE+1-500	25,0
cover (pmma) side 100 up to 500mm/opal	PS 100-500	30,0
cover (pmma) side extra 1 up to 500mm	PSE+1-500	25,0
colourfilter (white war, red, green, blue, lavender)	+PCOL color	3,0

CABLE SUSPENSION profile directional (max. lgt 1500mm), for lighting table or painting

cable suspension medium 670x50x40h with space for max. 4 adaptors 1-8 LEDs	PFC 40x50	200,0
cable suspension small 670x30x15h without space for adaptors	PFC 15x30	170,0

ADAPTORS 1 watt LEDs page 9 - 3 watt LEDs page 10

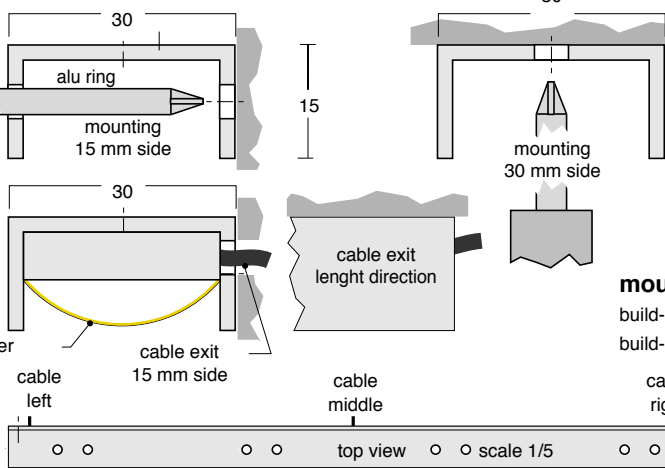
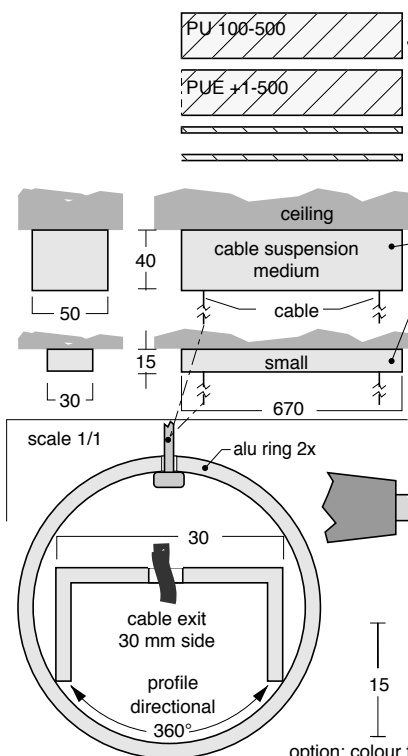

TOTAAL

total length
 profile _____ mm
 cover under _____ mm
 cover side _____ mm

mounting holes
 5 mm side
 30 mm side
 cable-suspension
 no holes

cable exit
 build-on 15 mm side
 build-in 30 mm side

length direction
 cable left
 cable middle
 cable right

agreement:
 signature
 date

Models, prices and dimensions (in mm) can be altered without previous notice.
Inclusive LEDs
 Prices in EURO



ADAPTORS 350mA for 1 watt LEDs



All models are registered and protected by prevailing laws.
 Scale 1/1 21.04.2009
 Design: Luc Lemahieu

230V - 1 circuit NOT DIMMABLE

art.code	input AC / DC output	dim. mm	€ in.
ZMPL1	190-265v / 350mA 1x1w	51x32x18	25
ZMPL3	190-265v / 350mA 2-3x1w	51x32x18	25
ZPLK110	190-265v / 350mA 1-8x1w	118x33x19	35
ZPLR110	190-265v / 350mA 1-8x1w	Ø53X19	35
ZDPL110	110-250v / 350mA 1-8x1w (USA)	117x50x28	40
ZPD312	190-265v / 350mA 3-12x1w	138x40x29	60

NOT DIMMABLE - outdoor use

ZNE1-2 350	100-240v / 350mA 1-2x1w IP54	75x40x31	25
ZNE1-8 PU11	230-240v / 350mA 1-7x1w IP54	90x39,5x29	45

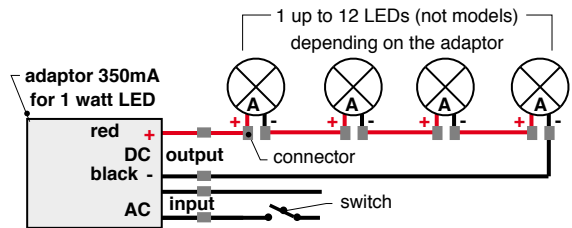

scheme - 1 circuit - not dimmable
1W - 350mA

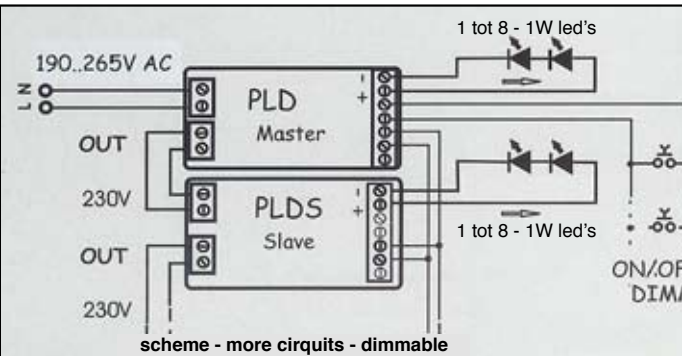

scheme - more circuits - dimmable
1W - 350mA

art.code	input AC / DC output	dim. mm	€ in.
ZPLD110M	190-265v / 350mA dim master 1-8x1w	165x41x28	55
ZPLD110S	190-265v / 350mA dim slave 1-8x1w	165x41x28	55

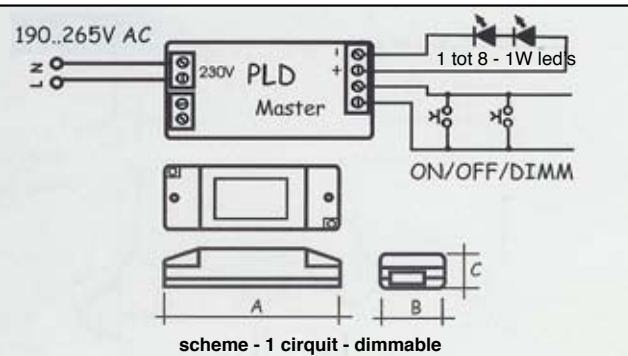

scheme - 1 circuit - dimmable
1W - 350mA

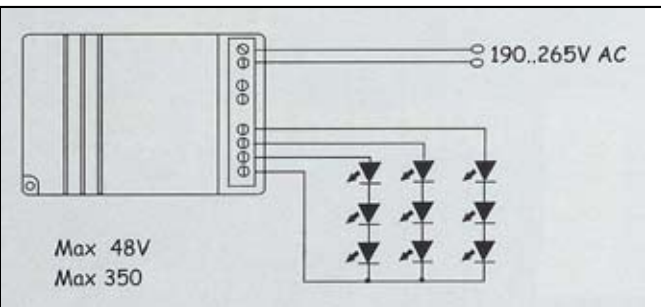

scheme - not dimmable: ZDBOX30 SP
1W - 350mA

230V - 3 circuits NOT DIMMABLE

art.code	input AC / DC output	dim. mm	€ in.
ZDBOX30 SP	190-265v / 350mA 3-24x1w	147x75x29	120

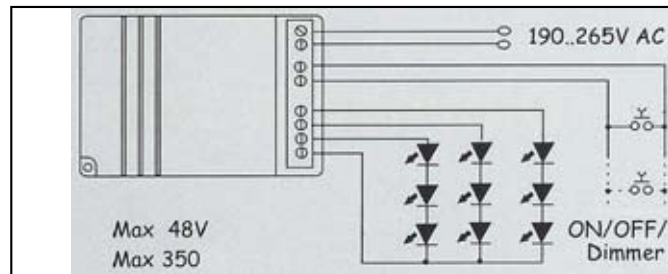

scheme - dimmable ZDBOX30
1W - 350mA

230V- 3 circuits DIMMABLE

art.code	input AC / DC output	dim. mm	€ in.
ZDBOX30	190-265v / 350mA 3-24x1w	147x75x29	150

on/off and dimming by push button (only contact if you push)

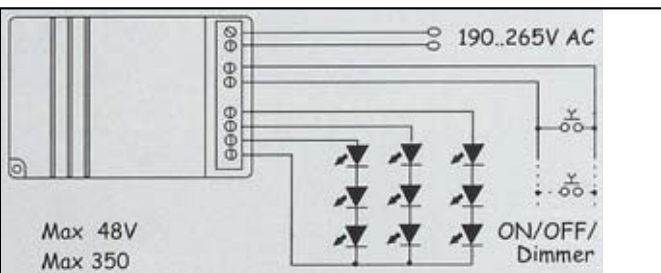

scheme - RGB ZRBOX
1W - 350mA

230V - 3 circuits RGB (for with red green & blue led's)

art.code	input AC / DC output	dim. mm	€ in.
ZRBOX	190-265v / 350mA RGB 3-24x1w	147x75x29	160

on/off and colour change by push button (only contact if you push)

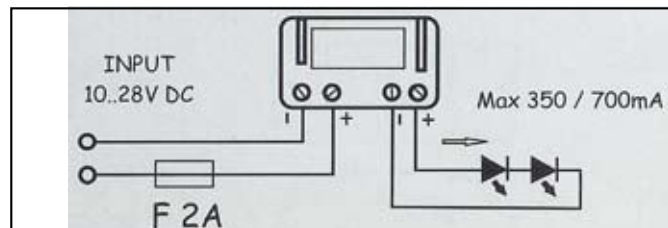

scheme 12 or 24V - not dimmable ZLVP 12-24V
1W - 350mA

BATTERY 12 or 24 V - 1 circuit NOT DIMMABLE

art.code	input 12 or 24V DC / DC output	dim. mm	€ in.
ZLVP 12-24V	10-28VDC / 350mA 1-3/6*x1w	51x32x18	25

*11..15V max. 3 leds - 22..28V max.6 leds

Models, prices and dimensions (in mm) can be altered without previous notice.
Inclusive LEDs and adaptor
Prices in EURO



ADAPTORS 700mA for 3 watt LEDs



All models are registered and protected by prevailing laws.
Scale 1/1 21.04.2009
Design: Luc Lemahieu

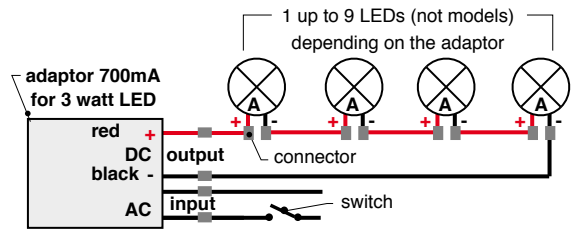

**scheme - 1 circuit - not dimmable
3W - 700mA**

230V - 1 circuit

NOT DIMMABLE

art.code	input AC / DC output	dim. mm	€ in.
ZMPL4	190-265v / 700mA 1x3w	51x32x18	30
ZPLK303	190-265v / 700mA 1-3x3w	118x33x19	40
ZPD309	190-250v / 700mA 3-8x3w	138x40x29	60
ZFB 310	190-250v / 700mA 3-8x3w	117x75x20	85

NOT DIMMABLE - outdoor use

ZNE3-4 700	100-240v / 700mA 3-4x3w IP54	75x50x33	30
ZNE1-3 PU13	230-240v / 700mA 1-3x3w IP54	90x40x29	45

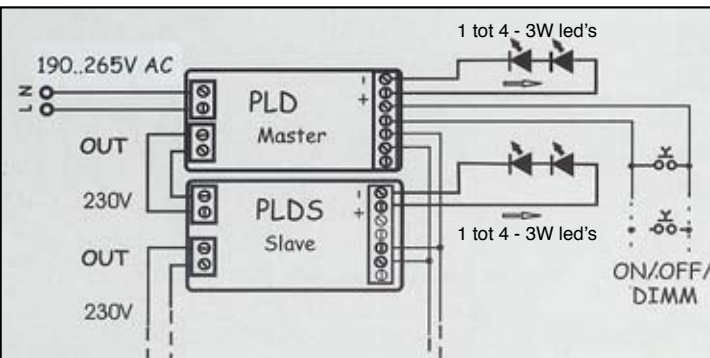

**scheme - more circuits - dimmable
3W - 700mA**

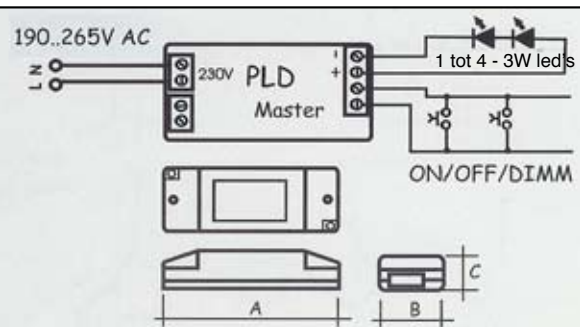

**scheme - 1 circuit - dimmable
3W - 700mA**

DIMMABLE 230V

art.code	input AC / DC output	dim. mm	€ in.
ZPLD304M	190-265v / 700mA dim. master 1-4x3w	165x41x28	55
ZPLD304S	190-265v / 700mA dim. slave 1-4x3w	165x41x28	55

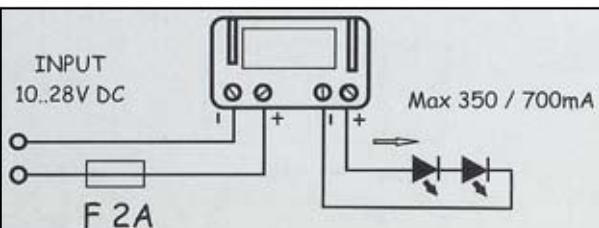

**scheme 12 or 24V - not dimmable ZLVQ 12-24V
3W - 700mA**

BATTERY 12 or 24 V - 1 circuit

NOT DIMMABLE

art.code	input 12 or 24V DC / DC output	dim. mm	€ in.
ZLVQ 12-24V	10-28VDC / 700mA 1-2/4** LEDs 3W	51x32x18	30

**11..15V max. 2 leds - 22..28V max.4 leds